



Erne AG  
Fenster + Fassaden  
Herr Thomas Witt  
Werkstrasse 3  
CH - 5080 Laufenburg

Luzern, 14. Februar 2006

**c1 1395**  
**Vision 3000 UK**  
**U-Wert-Berechnung, Wärmebrückenverlust bei Bauteilübergang**

Guten Tag Herr Witt

Gestützt auf die erhaltenen Unterlagen haben wir die  $U_f$ -Werte von einzelnen Rahmenpartien, den  $U_w$ -Wert von zwei Referenzfenstern und die  $\Psi_{\text{Einbau}}$ -Werte beim Fenstereinbau in ein Zweischalenmauerwerk rechnerisch überprüft (vgl. beiliegende Berechnungen) und fassen die Erkenntnisse wie folgt zusammen.

**1. Rahmen-U-Werte  $U_f$**

Aus der Berechnung des U-Wertes gemäss EN ISO 10077-2 haben sich für die einzelnen Rahmenpartien folgende  $U_f$ -Werte ergeben:

– Rahmen mit Flügel unten	1,405 W/m <sup>2</sup> K
– Rahmen mit Flügel seitlich und oben	1,313 W/m <sup>2</sup> K
– Mittelpartie	1,311 W/m <sup>2</sup> K
– Rahmen bei Festverglasung unten	1,559 W/m <sup>2</sup> K
– Rahmen bei Festverglasung seitlich und oben	1,308 W/m <sup>2</sup> K

**2. Fenster-U-Werte  $U_w$**

Für die zwei Referenzfenster ergeben sich, in Abhängigkeit der Verglasung, folgende  $U_w$ -Werte:

**2.1 Einflügliges Fenster (1,23 m x 1,48 m)**

– U-Wert der Verglasung	[W/m <sup>2</sup> K]	1,20	1,10	0,90	0,70	0,50
– $\Psi$ -Wert Randverbund	[W/mK]	0,05	0,05	0,05	0,05	0,05
– U-Wert des Fensters	[W/m <sup>2</sup> K]	<b>1,37</b>	<b>1,29</b>	<b>1,15</b>	<b>1,01</b>	<b>0,87</b>
– $\Psi$ -Wert Randverbund	[W/mK]	0,04	0,04	0,04	0,04	0,04
– U-Wert des Fensters	[W/m <sup>2</sup> K]	<b>1,34</b>	<b>1,27</b>	<b>1,13</b>	<b>0,98</b>	<b>0,84</b>

### 2.2 Festverglasung mit Flügel (1,23 x 1,48 m)

– U-Wert der Verglasung	[W/m <sup>2</sup> K]	1,20	1,10	0,90	0,70	0,50
– $\Psi$ -Wert Randverbund	[W/mK]	0,05	0,05	0,05	0,05	0,05
– U-Wert des Fensters	[W/m <sup>2</sup> K]	<b>1,44</b>	<b>1,38</b>	<b>1,25</b>	<b>1,13</b>	<b>1,00</b>
– $\Psi$ -Wert Randverbund	[W/mK]	0,04	0,04	0,04	0,04	0,04
– U-Wert des Fensters	[W/m <sup>2</sup> K]	<b>1,40</b>	<b>1,34</b>	<b>1,22</b>	<b>1,09</b>	<b>0,96</b>

### 3. Wärmebrückenverlust beim Einbau $\Psi_{\text{Einbau}}$

Der Wärmebrückenverlust  $\Psi_{\text{Einbau}}$  beträgt beim seitlichen Anschlag (Leibung)  $\Psi_{\text{Einbau}} = 0,093 \text{ W/mK}$  und beim unteren Anschlag (Brüstung)  $\Psi_{\text{Einbau}} = 0,097 \text{ W/mK}$ .

Wir hoffen, Ihnen mit diesen Abklärungen zu dienen und verbleiben mit freundlichen Grüßen.

RAGONESI · STROBEL & PARTNER AG

Marco Ragonesi, dipl. Architekt HTL



## Konstruktion

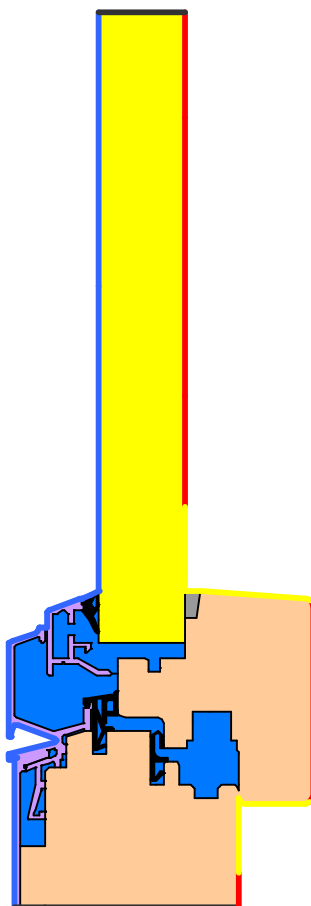

## Randbedingungen

Name	$q$ [W/m <sup>2</sup> ]	$\theta$ [°C]	$h$ [W/(m <sup>2</sup> ·K)]
Aussen Fenster		0.000	25.000
Innen Fensterrahmen Reduziert		20.000	5.000
Innen Fensterrahmen Standard		20.000	7.692
Symmetrie/Perfekt isoliert	0.000		

## Materialien

Name	$\lambda$ [W/(m·K)]
P1395: Aluminium	160.000
P1395: EPDM	0.200
P1395: Holzwerk	0.130
P1395: Kittdichtung	0.250
P1395: Panel (Glaserersatz)	0.035
P1395: Unbelüftete Hohlräume	

# Temperaturen

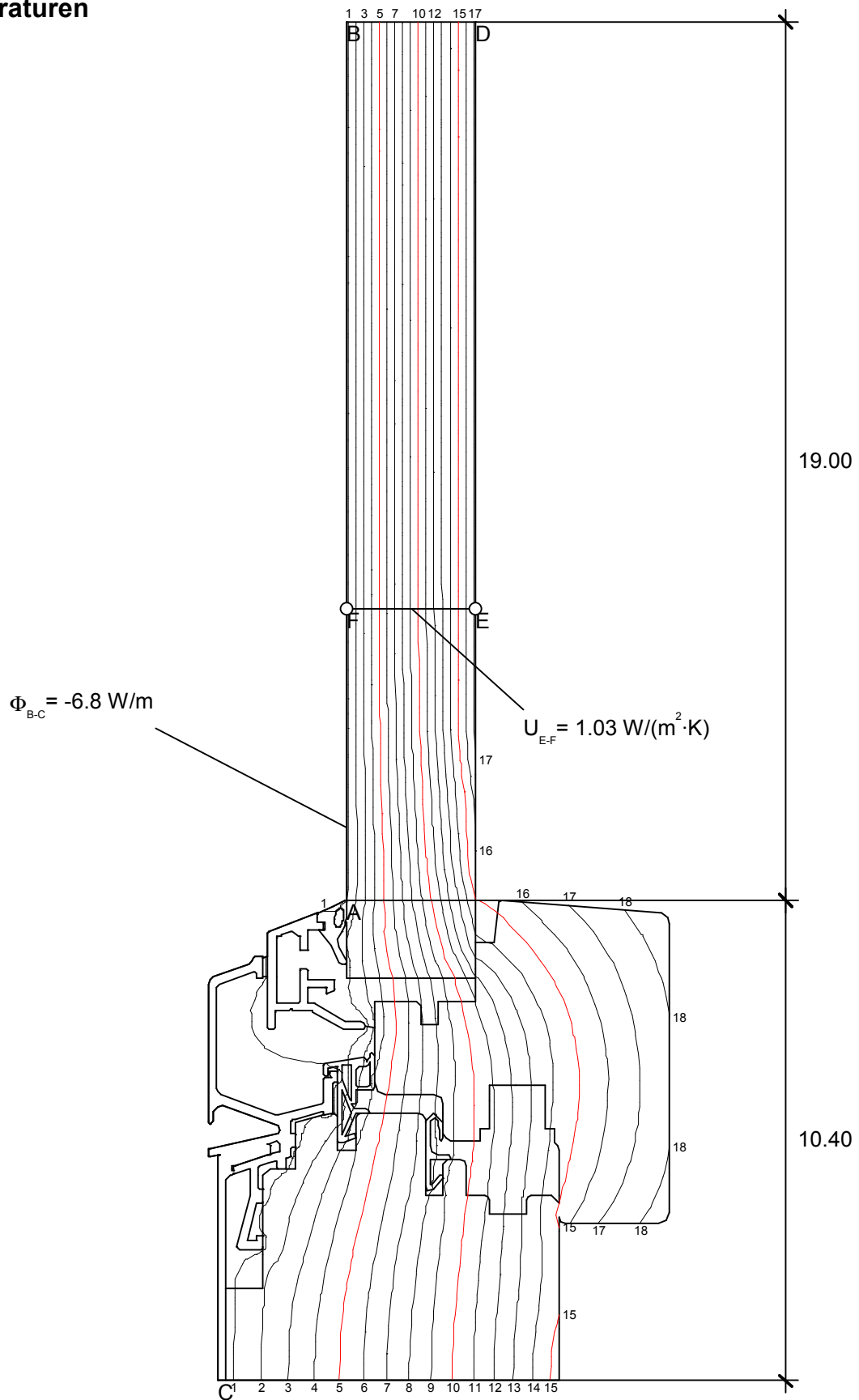

$$U_{fA} = \frac{\frac{\Phi}{\Delta T} - U_p \cdot b_p}{b_f} = \frac{\frac{-6.839}{-20.000} - 1.031 \cdot 0.190}{0.104} = 1.405 \text{ W}/(\text{m}^2 \cdot \text{K})$$

## Konstruktion

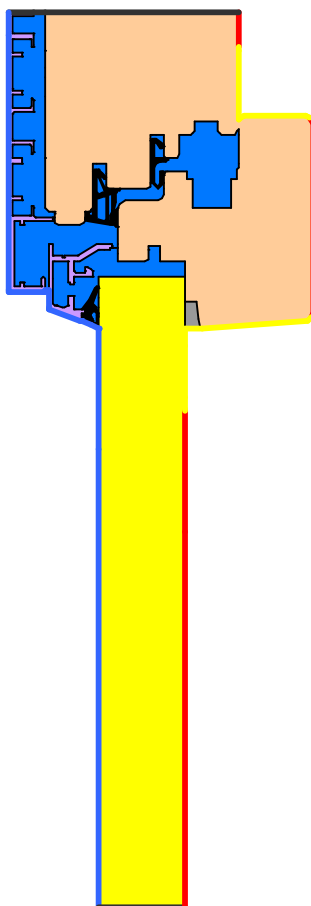

## Randbedingungen

Name	q[W/m <sup>2</sup> ]	θ[°C]	h[W/(m <sup>2</sup> ·K)]
Aussen Fenster		0.000	25.000
Innen Fensterrahmen Reduziert	20.000		5.000
Innen Fensterrahmen Standard	20.000		7.692
Symmetrie/Perfekt isoliert	0.000		

## Materialien

Name	λ[W/(m·K)]
P1395: Aluminium	160.000
P1395: EPDM	0.200
P1395: Holzwerk	0.130
P1395: Kittdichtung	0.250
P1395: Panel (Glaserersatz)	0.035
P1395: Unbelüftete Hohlräume	

# Temperaturen

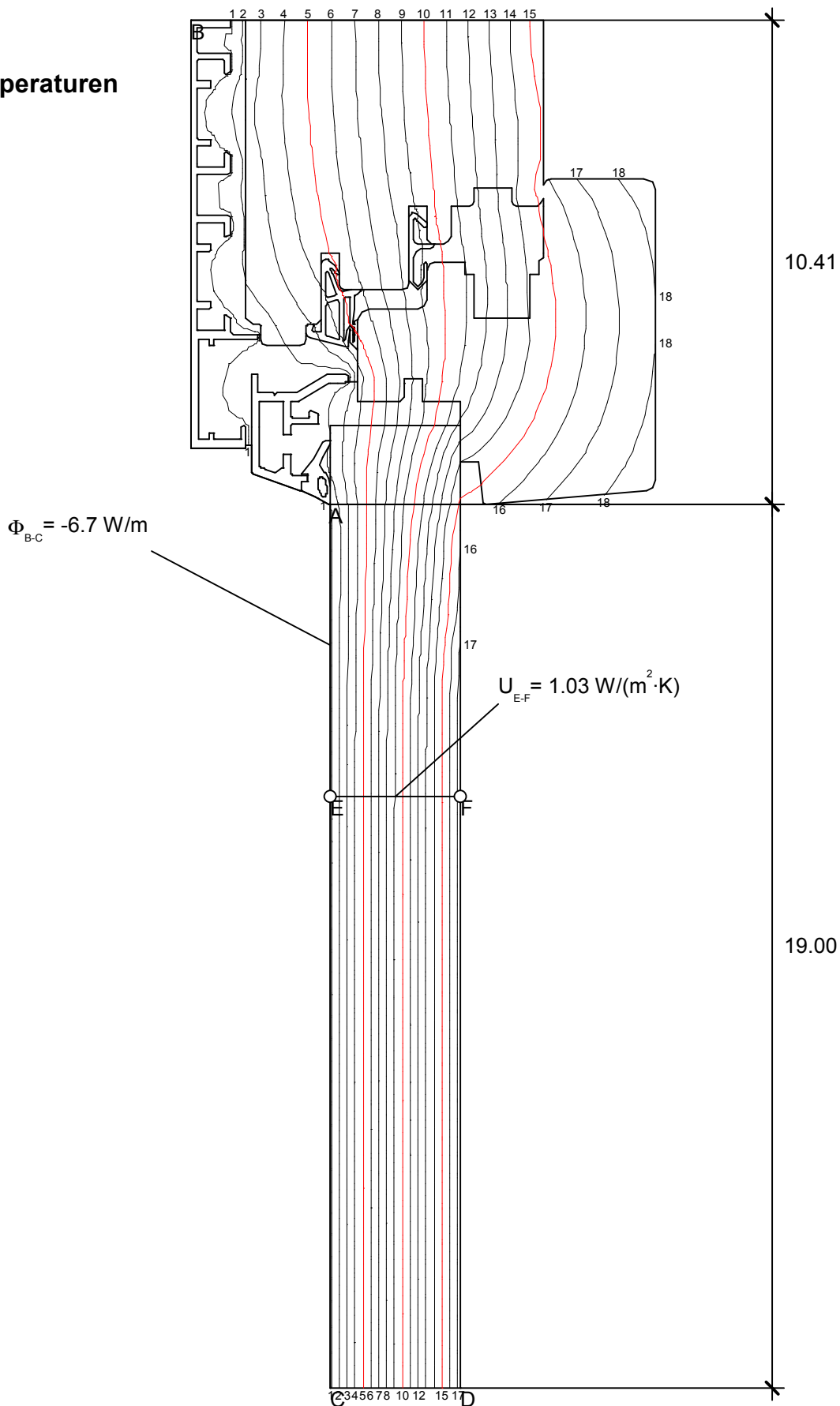

$$U_{fA} = \frac{\frac{\Phi}{\Delta T} - U_p \cdot b_p}{b_f} = \frac{\frac{-6.651}{-20.000} - 1.031 \cdot 0.190}{0.104} = 1.313 \text{ W/(m}^2 \cdot \text{K)}$$

# Konstruktion

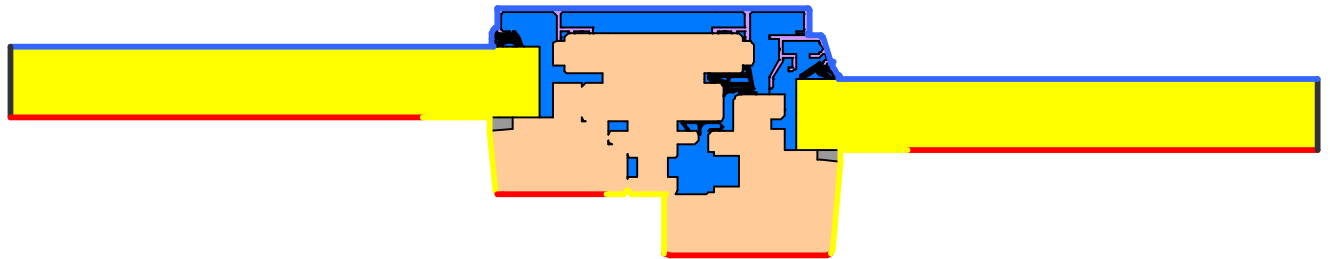

## Randbedingungen

Name	$q$ [W/m <sup>2</sup> ]	$\theta$ [°C]	$h$ [W/(m <sup>2</sup> ·K)]
Aussen Fenster		0.000	25.000
Innen Fensterrahmen Reduziert	20.000		5.000
Innen Fensterrahmen Standard	20.000		7.692
Symmetrie/Perfekt isoliert	0.000		

## Materialien

Name	$\lambda$ [W/(m·K)]
P1395: Aluminium	160.000
P1395: EPDM	0.200
P1395: Holzwerk	0.130
P1395: Kittdichtung	0.250
P1395: Panel (Glaserersatz)	0.035
P1395: Unbelüftete Hohlräume	

# Temperaturen

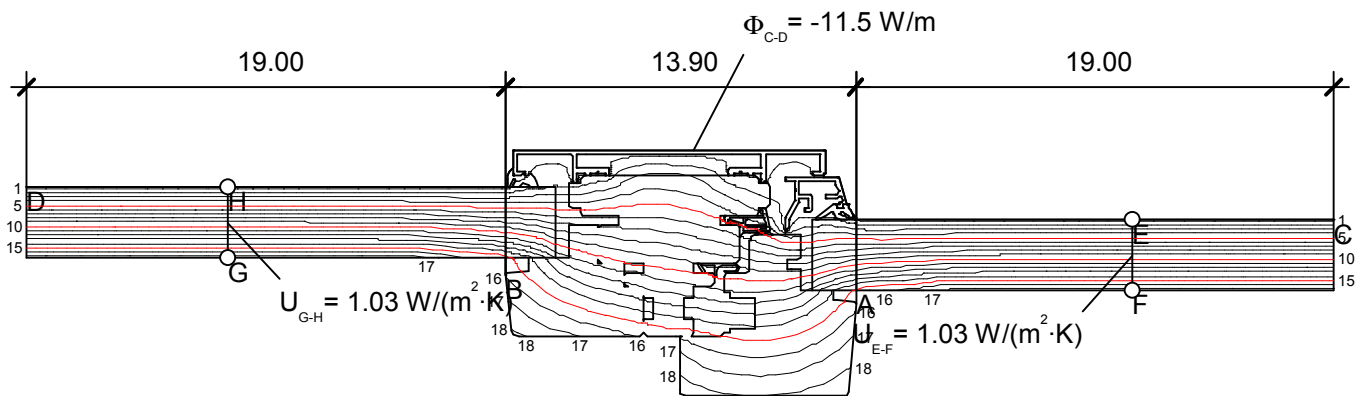



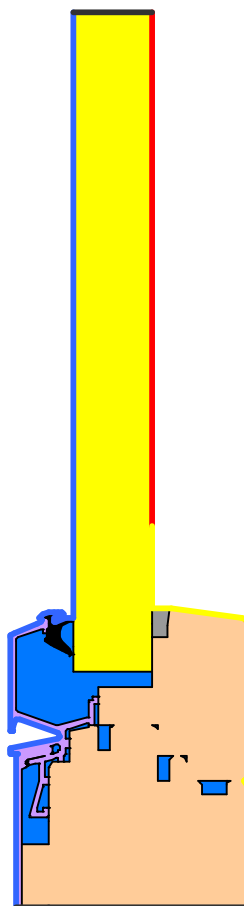

$$U_{fA,B} = \frac{\frac{\Phi}{\Delta T} - U_{p1} \cdot b_{p1} - U_{p2} \cdot b_{p2}}{b_f} = \frac{\frac{-11.479}{-20.000} - 1.031 \cdot 0.190 - 1.031 \cdot 0.190}{0.139} = 1.311 \text{ W/(m}^2 \cdot \text{K)}$$

## Konstruktion



## Randbedingungen

Name	$q$ [W/m <sup>2</sup> ]	$\theta$ [°C]	$h$ [W/(m <sup>2</sup> ·K)]
 Aussen Fenster		0.000	25.000
 Innen Fensterrahmen Reduziert		20.000	5.000
 Innen Fensterrahmen Standard		20.000	7.692
 Symmetrie/Perfekt isoliert	0.000		

## Materialien

Name	$\lambda$ [W/(m·K)]
 P1395: Aluminium	160.000
 P1395: EPDM	0.200
 P1395: Holzwerk	0.130
 P1395: Kittdichtung	0.250
 P1395: Panel (Glasersatz)	0.035
 P1395: Unbelüftete Hohlräume	

# Temperaturen

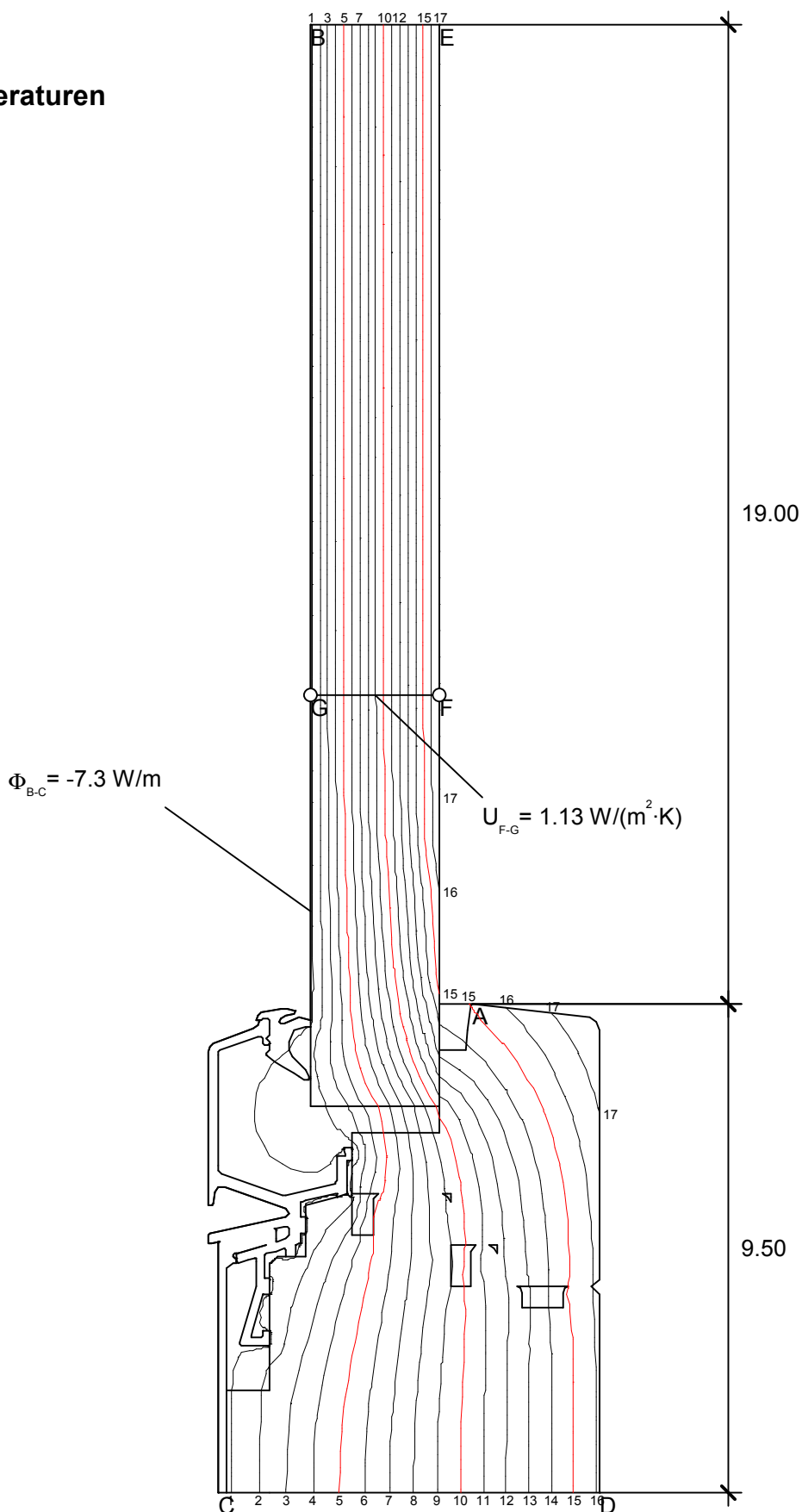

$$U_{fA} = \frac{\frac{\Phi}{\Delta T} - U_p \cdot b_p}{b_f} = \frac{\frac{-7.260}{-20.000} - 1.131 \cdot 0.190}{0.095} = 1.559 \text{ W/(m}^2 \cdot \text{K)}$$

## Konstruktion

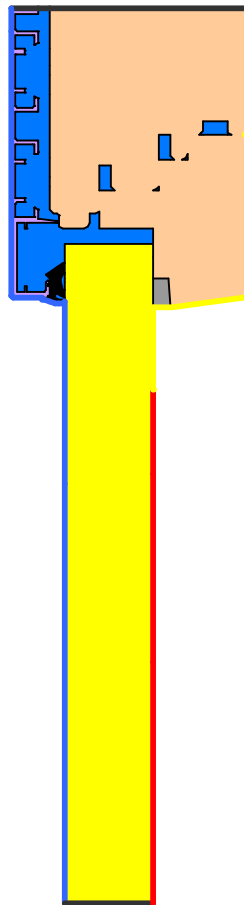

## Randbedingungen

Name	q[W/m <sup>2</sup> ]	θ[°C]	h[W/(m <sup>2</sup> ·K)]
Aussen Fenster		0.000	25.000
Innen Fensterrahmen Reduziert	20.000		5.000
Innen Fensterrahmen Standard	20.000		7.692
Symmetrie/Perfekt isoliert	0.000		

## Materialien

Name	λ[W/(m·K)]
P1395: Aluminium	160.000
P1395: EPDM	0.200
P1395: Holzwerk	0.130
P1395: Kittdichtung	0.250
P1395: Panel (Glaserersatz)	0.035
P1395: Unbelüftete Hohlräume	

# Temperaturen

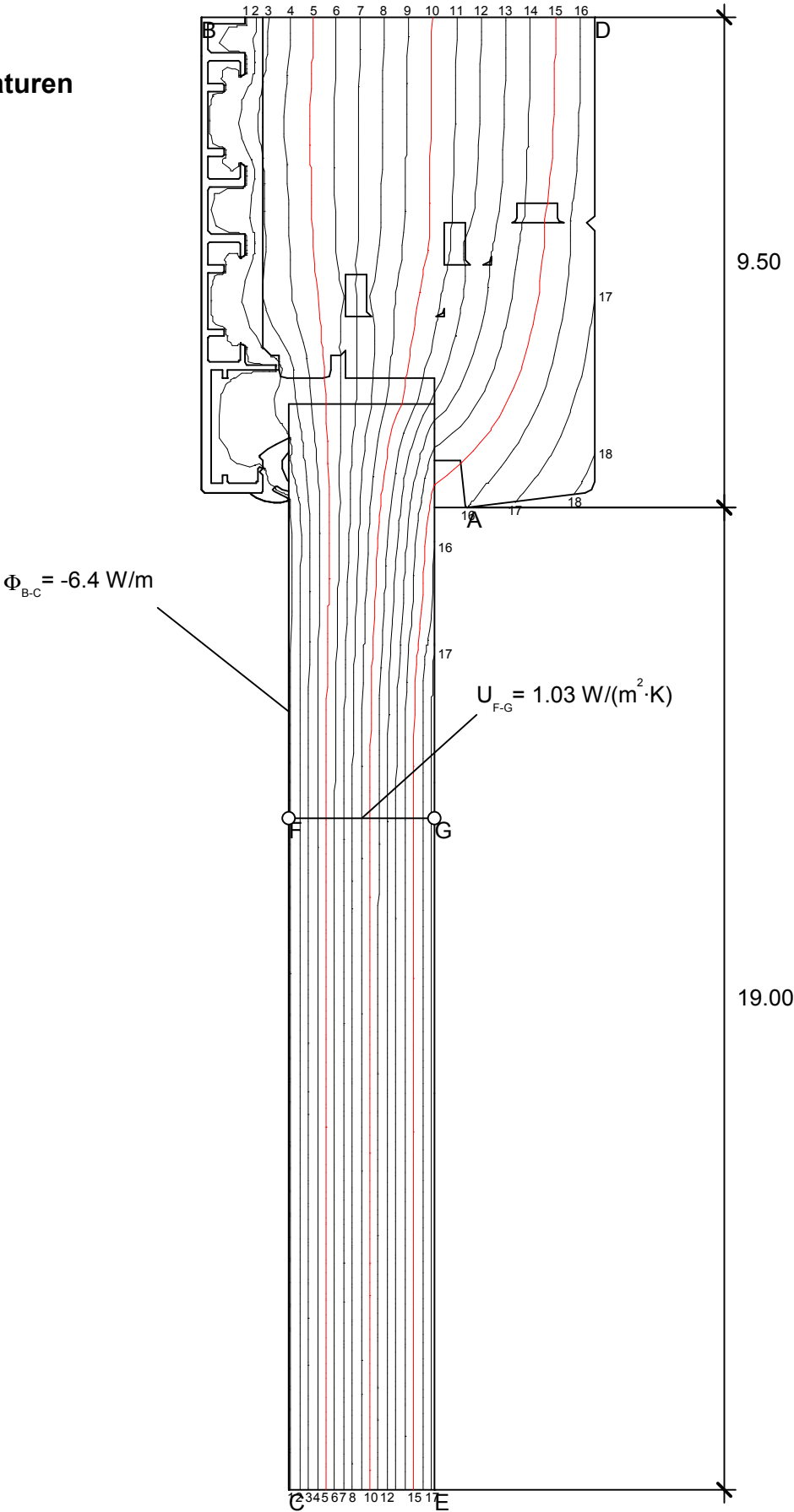





$$U_{fA} = \frac{\frac{\Phi}{\Delta T} - U_p \cdot b_p}{b_f} = \frac{\frac{-6.403}{-20.000} - 1.031 \cdot 0.190}{0.095} = 1.308 \text{ W/(m}^2 \cdot \text{K)}$$











# Konstruktion



## Randbedingungen

Name	q[W/m <sup>2</sup> ]	θ <sub>f</sub> [°C]	h[W/(m <sup>2</sup> ·K)]
 Aussen Fenster		0.000	25.000
 Innen Fensterrahmen Reduziert	20.000		5.000
 Innen Fensterrahmen Standard	20.000		7.692
 Innen Standard	20.000		7.700
 Symmetrie/Perfekt isoliert	0.000		

## Materialien

Name	λ[W/(m·K)]
 Backsteinmauerwerk	0.470
 Innenputz	0.700
 Klinkerstein	1.800
 P1395: Aluminium	160.000
 P1395: EPDM	0.200
 P1395: Holzwerk	0.130
 P1395: Kittdichtung	0.250
 P1395: Kunststoffprofil	0.180
 P1395: Panel (Glasersatz)	0.035
 P1395: Unbelüftete Hohlräume	
 Wärmedämmschicht	0.036

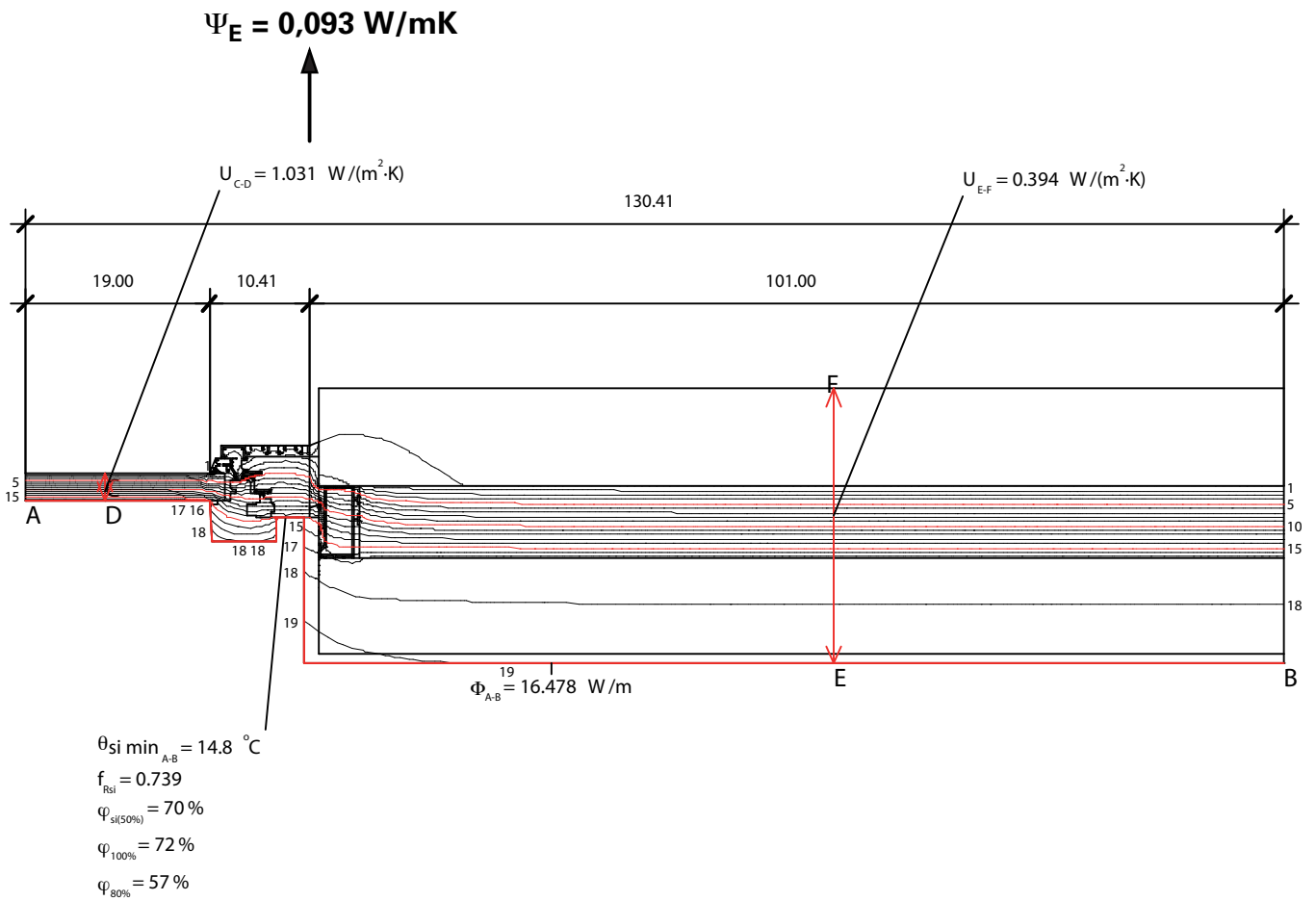



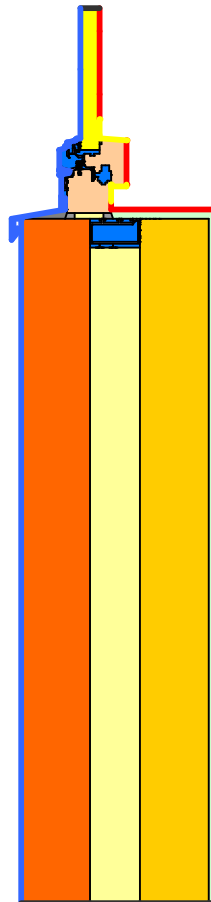

$$\Psi_E = \frac{16,478 - (1,01 \cdot 0,394 \cdot 20) - (0,1041 \cdot 1,313 \cdot 20) - (0,19 \cdot 1,031 \cdot 20)}{20} = 0,093 \text{ W/mK}$$













## Konstruktion



## Randbedingungen

Name	q[W/m <sup>2</sup> ]	θ[°C]	h[W/(m <sup>2</sup> ·K)]
 Aussen Fenster		0.000	25.000
 Innen Fensterrahmen Reduziert		20.000	5.000
 Innen Fensterrahmen Standard		20.000	7.692
 Innen Standard		20.000	7.700
 Symmetrie/Perfekt isoliert	0.000		

## Materialien

Name	λ[W/(m·K)]
 Backsteinmauerwerk	0.470
 Innenputz	0.700
 Klinkerstein	1.800
 Mörtelschicht	1.500
 P1395: Aluminium	160.000
 P1395: EPDM	0.200
 P1395: Holzwerk	0.130
 P1395: Kittdichtung	0.250
 P1395: Kunststoffprofil	0.180
 P1395: Panel (Glasersatz)	0.035
 P1395: Unbelüftete Hohlräume	
 Wärmedämmschicht	0.036

# Temperaturen

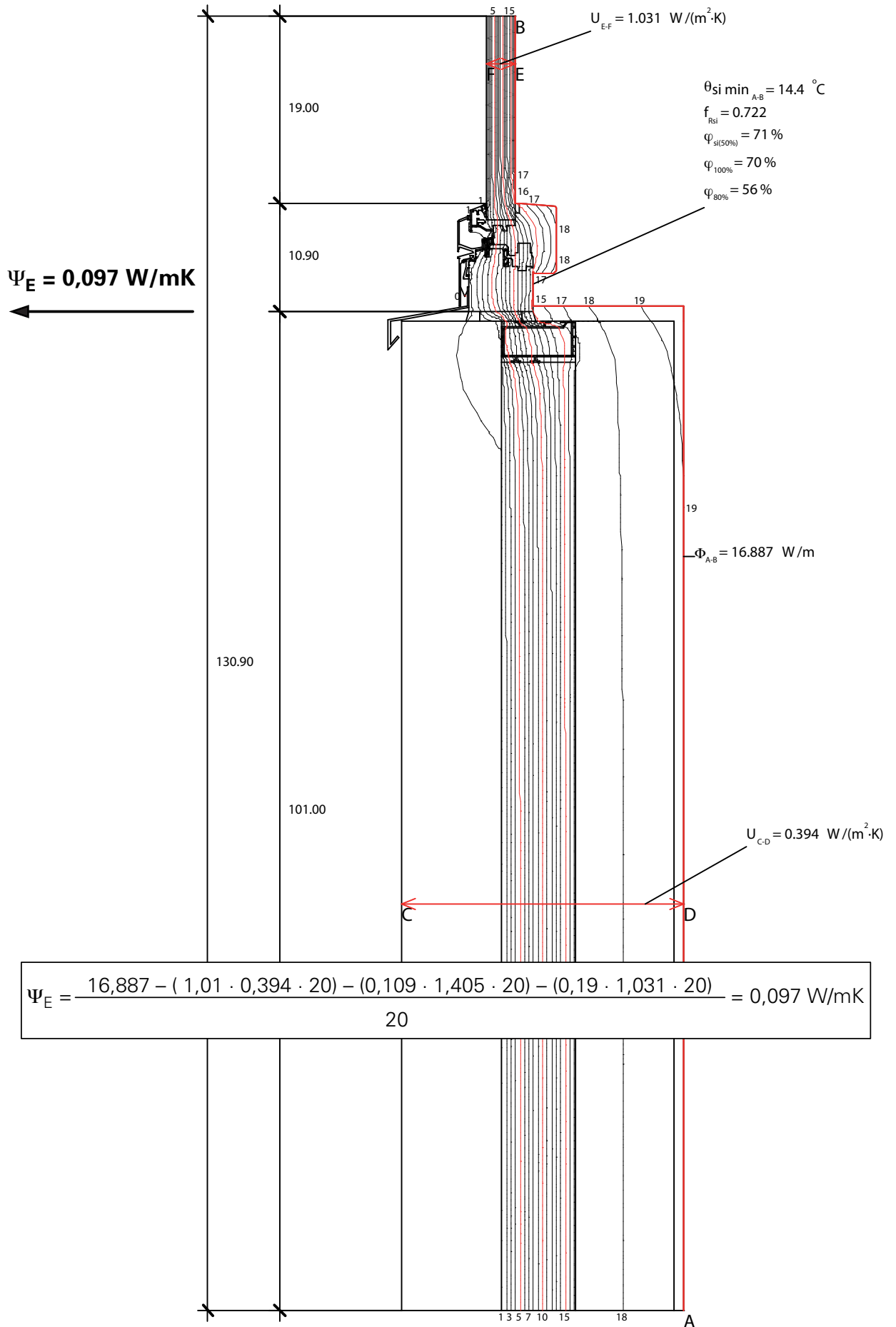

# Rahmen-U-Werte und Fenster-U-Werte

## ERNE AG, Vision 3000 UK: Einflügliges Fenster

### U-Wert Fensterrahmen

Rahmen seitlich	Rahmenfläche	[m <sup>2</sup> ]	0.265
	U-Wert	[W/m <sup>2</sup> K]	1.313
Rahmen oben	Rahmenfläche	[m <sup>2</sup> ]	0.128
	U-Wert	[W/m <sup>2</sup> K]	1.313
Rahmen unten	Rahmenfläche	[m <sup>2</sup> ]	0.128
	U-Wert	[W/m <sup>2</sup> K]	1.405
Rahmen mitte	Rahmenfläche	[m <sup>2</sup> ]	0.000
	U-Wert	[W/m <sup>2</sup> K]	0.000
Rahmen total	Rahmenfläche	[m <sup>2</sup> ]	0.521
	<b>U-Wert</b>	<b>[W/m<sup>2</sup>K]</b>	<b>1.336</b>

### U-Wert Fenster mit unterschiedlichen Gläsern (Abstandhalter Edelstahl)

Verglasung	U-Wert Glas	[W/m <sup>2</sup> K]	1.200	1.100	0.900	0.700	0.500
	Ψ-Wert Randverbund	[W/mK]	0.050	0.050	0.050	0.050	0.050
	Glasfläche	[m <sup>2</sup> ]	1.300	1.300	1.300	1.300	1.300
	Perimeter Randverbund	[m]	4.587	4.587	4.587	4.587	4.587
Rahmen	U-Wert Rahmen	[W/m <sup>2</sup> K]	1.336	1.336	1.336	1.336	1.336
	Rahmenfläche	[m <sup>2</sup> ]	0.521	0.521	0.521	0.521	0.521
Fenster	Fensterfläche	[m <sup>2</sup> ]	1.820	1.820	1.820	1.820	1.820
	<b>U-Wert Fenster</b>	<b>[W/m<sup>2</sup> K]</b>	<b>1.365</b>	<b>1.293</b>	<b>1.151</b>	<b>1.008</b>	<b>0.865</b>

### U-Wert Fenster mit unterschiedlichen Gläsern (Abstandhalter Kunststoff)

Verglasung	U-Wert Glas	[W/m <sup>2</sup> K]	1.200	1.100	0.900	0.700	0.500
	Ψ-Wert Randverbund	[W/mK]	0.040	0.040	0.040	0.040	0.040
	Glasfläche	[m <sup>2</sup> ]	1.300	1.300	1.300	1.300	1.300
	Perimeter Randverbund	[m]	4.587	4.587	4.587	4.587	4.587
Rahmen	U-Wert Rahmen	[W/m <sup>2</sup> K]	1.336	1.336	1.336	1.336	1.336
	Rahmenfläche	[m <sup>2</sup> ]	0.521	0.521	0.521	0.521	0.521
Fenster	Fensterfläche	[m <sup>2</sup> ]	1.820	1.820	1.820	1.820	1.820
	<b>U-Wert Fenster</b>	<b>[W/m<sup>2</sup> K]</b>	<b>1.340</b>	<b>1.268</b>	<b>1.125</b>	<b>0.983</b>	<b>0.840</b>

### U-Wert Fenster mit unterschiedlichen Gläsern (Abstandhalter Aluminium)

Verglasung	U-Wert Glas	[W/m <sup>2</sup> K]	1.200	1.100	0.900	0.700	0.500
	Ψ-Wert Randverbund	[W/mK]	0.070	0.070	0.070	0.070	0.070
	Glasfläche	[m <sup>2</sup> ]	1.300	1.300	1.300	1.300	1.300
	Perimeter Randverbund	[m]	4.587	4.587	4.587	4.587	4.587
Rahmen	U-Wert Rahmen	[W/m <sup>2</sup> K]	1.336	1.336	1.336	1.336	1.336
	Rahmenfläche	[m <sup>2</sup> ]	0.521	0.521	0.521	0.521	0.521
Fenster	Fensterfläche	[m <sup>2</sup> ]	1.820	1.820	1.820	1.820	1.820
	<b>U-Wert Fenster</b>	<b>[W/m<sup>2</sup> K]</b>	<b>1.415</b>	<b>1.344</b>	<b>1.201</b>	<b>1.058</b>	<b>0.915</b>

# Rahmen-U-Werte und Fenster-U-Werte

## ERNE AG, Vision 3000 UK: Fenster mit Festverglasung und Flügel

### U-Wert Fensterrahmen

			Fest	Flügel
Rahmen seitlich	Rahmenfläche	[m <sup>2</sup> ]	0.123	0.133
	U-Wert	[W/m <sup>2</sup> K]	1.308	1.313
Rahmen oben	Rahmenfläche	[m <sup>2</sup> ]	0.058	0.064
	U-Wert	[W/m <sup>2</sup> K]	1.308	1.313
Rahmen unten	Rahmenfläche	[m <sup>2</sup> ]	0.058	0.064
	U-Wert	[W/m <sup>2</sup> K]	1.559	1.405
Rahmen mitte	Rahmenfläche	[m <sup>2</sup> ]	0.179	0.000
	U-Wert	[W/m <sup>2</sup> K]	1.311	0.000
Rahmen total	Rahmenfläche	[m <sup>2</sup> ]	0.679	
	<b>U-Wert</b>	<b>[W/m<sup>2</sup>K]</b>	<b>1.341</b>	

### U-Wert Fenster mit unterschiedlichen Gläsern (Abstandhalter Edelstahl)

Verglasung	U-Wert Glas	[W/m <sup>2</sup> K]	1.200	1.100	0.900	0.700	0.500
	Ψ-Wert Randverbund	[W/mK]	0.050	0.050	0.050	0.050	0.050
	Glasfläche	[m <sup>2</sup> ]	1.146	1.146	1.146	1.146	1.146
	Perimeter Randverbund	[m]	6.922	6.922	6.922	6.922	6.922
Rahmen	U-Wert Rahmen	[W/m <sup>2</sup> K]	1.341	1.341	1.341	1.341	1.341
	Rahmenfläche	[m <sup>2</sup> ]	0.675	0.675	0.675	0.675	0.675
Fenster	Fensterfläche	[m <sup>2</sup> ]	1.820	1.820	1.820	1.820	1.820
	<b>U-Wert Fenster</b>	<b>[W/m<sup>2</sup> K]</b>	<b>1.442</b>	<b>1.379</b>	<b>1.254</b>	<b>1.128</b>	<b>1.002</b>

### U-Wert Fenster mit unterschiedlichen Gläsern (Abstandhalter Kunststoff)

Verglasung	U-Wert Glas	[W/m <sup>2</sup> K]	1.200	1.100	0.900	0.700	0.500
	Ψ-Wert Randverbund	[W/mK]	0.040	0.040	0.040	0.040	0.040
	Glasfläche	[m <sup>2</sup> ]	1.146	1.146	1.146	1.146	1.146
	Perimeter Randverbund	[m]	6.922	6.922	6.922	6.922	6.922
Rahmen	U-Wert Rahmen	[W/m <sup>2</sup> K]	1.341	1.341	1.341	1.341	1.341
	Rahmenfläche	[m <sup>2</sup> ]	0.675	0.675	0.675	0.675	0.675
Fenster	Fensterfläche	[m <sup>2</sup> ]	1.820	1.820	1.820	1.820	1.820
	<b>U-Wert Fenster</b>	<b>[W/m<sup>2</sup> K]</b>	<b>1.404</b>	<b>1.341</b>	<b>1.216</b>	<b>1.090</b>	<b>0.964</b>

### U-Wert Fenster mit unterschiedlichen Gläsern (Abstandhalter Aluminium)

Verglasung	U-Wert Glas	[W/m <sup>2</sup> K]	1.200	1.100	0.900	0.700	0.500
	Ψ-Wert Randverbund	[W/mK]	0.070	0.070	0.070	0.070	0.070
	Glasfläche	[m <sup>2</sup> ]	1.146	1.146	1.146	1.146	1.146
	Perimeter Randverbund	[m]	6.922	6.922	6.922	6.922	6.922
Rahmen	U-Wert Rahmen	[W/m <sup>2</sup> K]	1.341	1.341	1.341	1.341	1.341
	Rahmenfläche	[m <sup>2</sup> ]	0.675	0.675	0.675	0.675	0.675
Fenster	Fensterfläche	[m <sup>2</sup> ]	1.820	1.820	1.820	1.820	1.820
	<b>U-Wert Fenster</b>	<b>[W/m<sup>2</sup> K]</b>	<b>1.518</b>	<b>1.455</b>	<b>1.330</b>	<b>1.204</b>	<b>1.078</b>

# Rahmen-U-Werte und Fenster-U-Werte

## ERNE AG, Vision 3000 UK: Einflügliges Fenster

### U-Wert Fensterrahmen

Rahmen seitlich	Rahmenfläche	[m <sup>2</sup> ]	0.265
	U-Wert	[W/m <sup>2</sup> K]	1.313
Rahmen oben	Rahmenfläche	[m <sup>2</sup> ]	0.128
	U-Wert	[W/m <sup>2</sup> K]	1.313
Rahmen unten	Rahmenfläche	[m <sup>2</sup> ]	0.128
	U-Wert	[W/m <sup>2</sup> K]	1.405
Rahmen mitte	Rahmenfläche	[m <sup>2</sup> ]	0.000
	U-Wert	[W/m <sup>2</sup> K]	0.000
Rahmen total	Rahmenfläche	[m <sup>2</sup> ]	0.521
	<b>U-Wert</b>	<b>[W/m<sup>2</sup>K]</b>	<b>1.336</b>

### U-Wert Fenster mit unterschiedlichen Gläsern (Abstandhalter Edelstahl)

Verglasung	U-Wert Glas	[W/m <sup>2</sup> K]	1.500	1.400	1.300	1.200	1.100
	Ψ-Wert Randverbund	[W/mK]	0.050	0.050	0.050	0.050	0.050
	Glasfläche	[m <sup>2</sup> ]	1.300	1.300	1.300	1.300	1.300
	Perimeter Randverbund	[m]	4.587	4.587	4.587	4.587	4.587
Rahmen	U-Wert Rahmen	[W/m <sup>2</sup> K]	1.336	1.336	1.336	1.336	1.336
	Rahmenfläche	[m <sup>2</sup> ]	0.521	0.521	0.521	0.521	0.521
Fenster	Fensterfläche	[m <sup>2</sup> ]	1.820	1.820	1.820	1.820	1.820
	<b>U-Wert Fenster</b>	<b>[W/m<sup>2</sup> K]</b>	<b>1.579</b>	<b>1.508</b>	<b>1.436</b>	<b>1.365</b>	<b>1.293</b>

### U-Wert Fenster mit unterschiedlichen Gläsern (Abstandhalter Kunststoff)

Verglasung	U-Wert Glas	[W/m <sup>2</sup> K]	1.500	1.400	1.300	1.200	1.100
	Ψ-Wert Randverbund	[W/mK]	0.040	0.040	0.040	0.040	0.040
	Glasfläche	[m <sup>2</sup> ]	1.300	1.300	1.300	1.300	1.300
	Perimeter Randverbund	[m]	4.587	4.587	4.587	4.587	4.587
Rahmen	U-Wert Rahmen	[W/m <sup>2</sup> K]	1.336	1.336	1.336	1.336	1.336
	Rahmenfläche	[m <sup>2</sup> ]	0.521	0.521	0.521	0.521	0.521
Fenster	Fensterfläche	[m <sup>2</sup> ]	1.820	1.820	1.820	1.820	1.820
	<b>U-Wert Fenster</b>	<b>[W/m<sup>2</sup> K]</b>	<b>1.554</b>	<b>1.482</b>	<b>1.411</b>	<b>1.340</b>	<b>1.268</b>

### U-Wert Fenster mit unterschiedlichen Gläsern (Abstandhalter Aluminium)

Verglasung	U-Wert Glas	[W/m <sup>2</sup> K]	1.500	1.400	1.300	1.200	1.100
	Ψ-Wert Randverbund	[W/mK]	0.070	0.070	0.070	0.070	0.070
	Glasfläche	[m <sup>2</sup> ]	1.300	1.300	1.300	1.300	1.300
	Perimeter Randverbund	[m]	4.587	4.587	4.587	4.587	4.587
Rahmen	U-Wert Rahmen	[W/m <sup>2</sup> K]	1.336	1.336	1.336	1.336	1.336
	Rahmenfläche	[m <sup>2</sup> ]	0.521	0.521	0.521	0.521	0.521
Fenster	Fensterfläche	[m <sup>2</sup> ]	1.820	1.820	1.820	1.820	1.820
	<b>U-Wert Fenster</b>	<b>[W/m<sup>2</sup> K]</b>	<b>1.629</b>	<b>1.558</b>	<b>1.487</b>	<b>1.415</b>	<b>1.344</b>

# Rahmen-U-Werte und Fenster-U-Werte

## ERNE AG, Vision 3000 UK: Fenster mit Festverglasung und Flügel

U-Wert Fensterrahmen			Fest	Flügel
Rahmen seitlich	Rahmenfläche	[m <sup>2</sup> ]	0.123	0.133
	U-Wert	[W/m <sup>2</sup> K]	1.308	1.313
Rahmen oben	Rahmenfläche	[m <sup>2</sup> ]	0.058	0.064
	U-Wert	[W/m <sup>2</sup> K]	1.308	1.313
Rahmen unten	Rahmenfläche	[m <sup>2</sup> ]	0.058	0.064
	U-Wert	[W/m <sup>2</sup> K]	1.559	1.405
Rahmen mitte	Rahmenfläche	[m <sup>2</sup> ]	0.179	0.000
	U-Wert	[W/m <sup>2</sup> K]	1.311	0.000
Rahmen total	Rahmenfläche	[m <sup>2</sup> ]	0.679	
	<b>U-Wert</b>	<b>[W/m<sup>2</sup>K]</b>	<b>1.341</b>	

### U-Wert Fenster mit unterschiedlichen Gläsern (Abstandhalter Edelstahl)

Verglasung	U-Wert Glas	[W/m <sup>2</sup> K]	1.500	1.400	1.300	1.200	1.100
	Ψ-Wert Randverbund	[W/mK]	0.050	0.050	0.050	0.050	0.050
	Glasfläche	[m <sup>2</sup> ]	1.146	1.146	1.146	1.146	1.146
	Perimeter Randverbund	[m]	6.922	6.922	6.922	6.922	6.922
Rahmen	U-Wert Rahmen	[W/m <sup>2</sup> K]	1.341	1.341	1.341	1.341	1.341
	Rahmenfläche	[m <sup>2</sup> ]	0.675	0.675	0.675	0.675	0.675
Fenster	Fensterfläche	[m <sup>2</sup> ]	1.820	1.820	1.820	1.820	1.820
	<b>U-Wert Fenster</b>	<b>[W/m<sup>2</sup> K]</b>	<b>1.631</b>	<b>1.568</b>	<b>1.505</b>	<b>1.442</b>	<b>1.379</b>

### U-Wert Fenster mit unterschiedlichen Gläsern (Abstandhalter Kunststoff)

Verglasung	U-Wert Glas	[W/m <sup>2</sup> K]	1.500	1.400	1.300	1.200	1.100
	Ψ-Wert Randverbund	[W/mK]	0.040	0.040	0.040	0.040	0.040
	Glasfläche	[m <sup>2</sup> ]	1.146	1.146	1.146	1.146	1.146
	Perimeter Randverbund	[m]	6.922	6.922	6.922	6.922	6.922
Rahmen	U-Wert Rahmen	[W/m <sup>2</sup> K]	1.341	1.341	1.341	1.341	1.341
	Rahmenfläche	[m <sup>2</sup> ]	0.675	0.675	0.675	0.675	0.675
Fenster	Fensterfläche	[m <sup>2</sup> ]	1.820	1.820	1.820	1.820	1.820
	<b>U-Wert Fenster</b>	<b>[W/m<sup>2</sup> K]</b>	<b>1.593</b>	<b>1.530</b>	<b>1.467</b>	<b>1.404</b>	<b>1.341</b>

### U-Wert Fenster mit unterschiedlichen Gläsern (Abstandhalter Aluminium)

Verglasung	U-Wert Glas	[W/m <sup>2</sup> K]	1.500	1.400	1.300	1.200	1.100
	Ψ-Wert Randverbund	[W/mK]	0.070	0.070	0.070	0.070	0.070
	Glasfläche	[m <sup>2</sup> ]	1.146	1.146	1.146	1.146	1.146
	Perimeter Randverbund	[m]	6.922	6.922	6.922	6.922	6.922
Rahmen	U-Wert Rahmen	[W/m <sup>2</sup> K]	1.341	1.341	1.341	1.341	1.341
	Rahmenfläche	[m <sup>2</sup> ]	0.675	0.675	0.675	0.675	0.675
Fenster	Fensterfläche	[m <sup>2</sup> ]	1.820	1.820	1.820	1.820	1.820
	<b>U-Wert Fenster</b>	<b>[W/m<sup>2</sup> K]</b>	<b>1.707</b>	<b>1.644</b>	<b>1.581</b>	<b>1.518</b>	<b>1.455</b>